

# Domain®

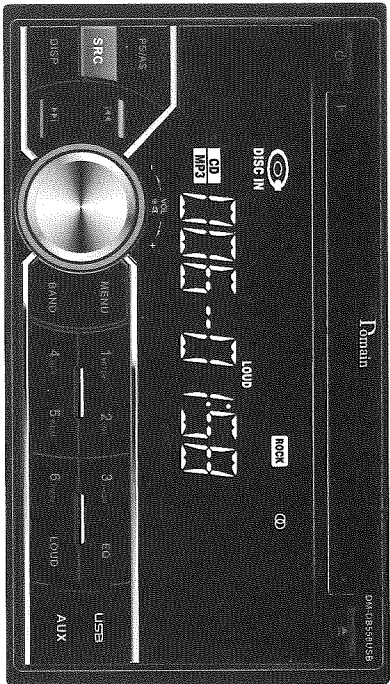

**DM-DB558USB**  
CD/MP3/USB Player with FM/MW Tuner  
**Operating Instructions**

## SAFETY INFORMATION

Thank you for purchasing this product. Please read through these operating instructions so you will know how to operate your model properly. After you have finished reading the instructions, keep this manual in a safe place for future reference.

### PRECAUTIONS

- Use only in a 12-volt DC negative-ground electrical system.
- Disconnect the vehicle's negative battery terminal while mounting and connecting the unit.
- When replacing the fuse, be sure to use one with an identical amperage rating.
- Using a fuse with a higher amperage rating may cause serious damage to the unit.
- DO NOT attempt to disassemble the unit.
- Laser beams from the optical pickup are dangerous to the eyes.
- Make sure those pins or other objects do not get inside the unit, they may cause malfunctions, or create safety hazards such as electrical shock or laser beam exposure.
- If you have parked the car for a long time in hot or cold weather, wait until the temperature in the car become normal before operating the unit.
- Keep the volume at a level at which you can hear outside warning sounds (horns sirens, etc.).
- Stop the car before performing any complicated operation.

### CD NOTES

- Playing a defective or dusty CD can cause dropouts in sound.
- Handle the disc by holding its inner and outer edges. Do not touch the surface of the unlabeled side of the disc.
- Do not touch the unlabeled side.
- Do not attach any seal, label or data protection sheet to either side of a disc.
- Do not expose a CD to direct sunlight or excessive heat.
- Wipe a dirty CD from the center outward with a cleaning cloth.
- Never use solvents such as benzine or alcohol.
- This unit can not play 3-inch (8cm ) CDs. Never insert a 3-inch CD contained in the adapter or an irregularly shaped CD. The unit may not be able to eject it, resulting in a malfunction.
- In addition to ordinary CDs, this unit can play back a CD-R/CD-RW/MP3/UDF/CD-TEXT.

### CAUTION

Please power off this unit at once and send it back to the after-sales service center or the dealer /distributor you purchased from if one of the following symptoms is found:

- (1) Water or other obstacle enters the unit;
- (2) Smoking;
- (3) Peculiar smell.

## CONTENTS

Safety Information .....	2
Panel Controls .....	3
Remote Controls .....	4
General Operation .....	5
Sound Setting .....	5
CD/MP3/WMA Operation .....	6
USB Playback .....	8
Tuner Operation .....	9
Menu Function .....	9
Electrical Connections .....	10
Installation Guide .....	11
Troubleshooting .....	12
Specifications .....	13

To provide a clear demonstration and an alternative for easy understanding of the operation of this unit, graphic illustration was used. However, this illustration is not necessary, printed as the actual image found on the unit.

# PANEL CONTROLS

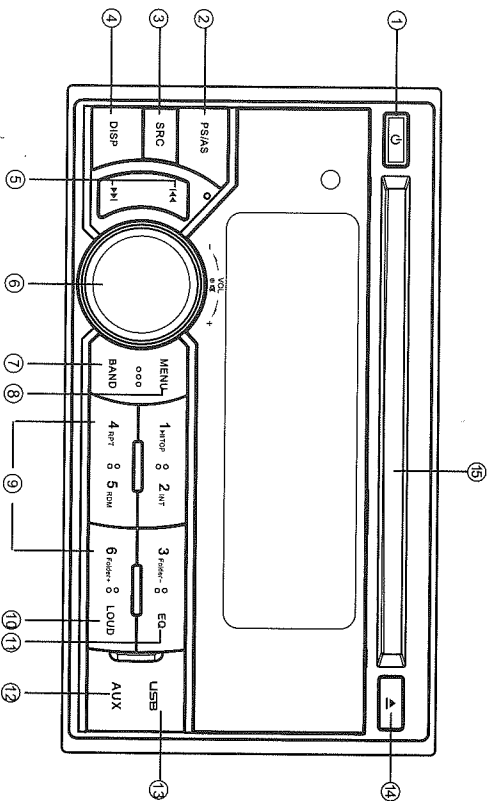

1. - Power
2. - Scan play / Preset scan
3. - Auto memory store (long press)
4. - Toggle the audio source
5. - Display switch
6. - System setup (long press)
7. - Previous / next track
8. - Seek + / - (long press)
9. - Adjust volume level / Confirm (press) MUTE
10. - Band switch (in Radio mode)
11. - MP3/WMA DISC mode - Search function.
12. - CD mode - No function.
13. - AUX mode - No function.

9. - Button 1: Play / Pause / Top play (long press) / Preset station 1
- Button 2: Scan play / Preset station 2.
- Button 3: Previous folder / Preset station 3. /MP3 track -10 down (long press)
- Button 4: Repeat play / Preset station 4.
- Button 5: Random play / Preset station 5.
- Button 6: Next folder / Preset station 6. /MP3 track +10 up (long press)
10. - Loudness
11. - Sound effect setting
12. - Aux-in jack
13. - USB connector
14. - Press to eject disc.
15. - Disc slot

## REMOTE CONTROLS

### Remote control operating range

The remote control can operate within a distance of 3-5m.

Point the top of remote control to the remote sensor when you operate with it.

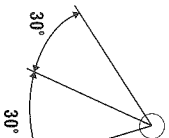

Remote sensor

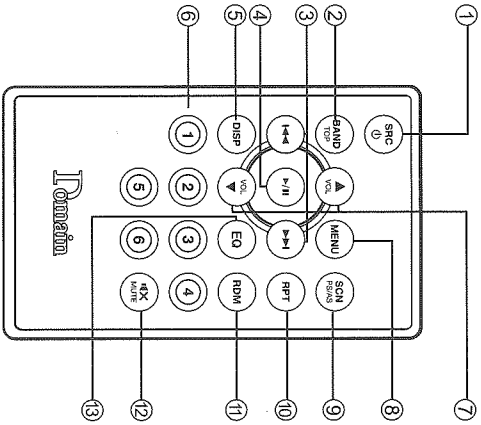

1. - Toggle the audio source
  - Power on / Power off (long press)
2. - Band switch: FM1, FM2, FM3, MW1, MW2 -MP3/WMA mode - Top play (long press) - CD mode - Top play (long press)
3. - Radio tune
  - Track seek
  - Play / Pause
4. - Display switch
5. - Buttons
  - [1] Button: Preset station 1.
  - [2] Button: Preset station 2.
  - [3] Button: Preset station 3.
  - [4] Button: Preset station 4.
  - [5] Button: Preset station 5.
  - [6] Button: Preset station 6.
6. - Volume up / down
7. - Scan play / Preset scan
8. - Auto memory store (long press)
9. - Repeat play
10. - Random play
11. - Mute the volume
12. - EQ

### Replacing the lithium battery of remote control unit.

When the range of the operation of the card remote control becomes short or no functions while operating. Replace the battery with a new lithium battery. Make sure the battery Polarity replacement is correct.

1. Pull out the battery holder while pressing the stopper.
2. Insert the button-type battery with the stamped(+) mark facing upward. Insert the battery holder into the remote control.



### WARNING:

- Store the battery in place where children cannot reach. If a child accidentally swallowed the battery, consult a doctor immediately.
- Do not recharge, short, disassemble or heat the battery or dispose it in a fire. Doing this may cause the battery to give off heat, crack or start a fire.
- Do not leave the battery with other metallic materials or poke the battery with tweezers or similar tools.
- When throwing away or saving the battery, wrap it in tape and insulate.

## GENERAL OPERATION

### Power On/Off Button

Press the [  $\phi$  ] button to turn the unit on when the vehicle ignition switch is on. Press and hold the button to turn the unit off.

### Adjust Volume level

Rotate the knob to adjust volume level. Rotate it clockwise to increase and anticlockwise to decrease the volume.

### Audio Mute

Press the [ VOL ] button to mute the volume from the system. "MUTE" will appear on the display panel and the volume will be muted. Press the [ VOL ] button again, or rotate the knob to return the volume level to the setting in use before the Mute function was activated.

### Mode Button (SRC)

Press the [SRC] button to change between Radio, DISC (when disc is in), USB (when USB is connected), or AUX play.

### Auxiliary Input

To access an auxiliary device:

1. Connect the portable audio player to the AUX interface on the front panel.
2. Press the [SRC] button to select Aux-In mode.

Press SRC again to cancel Aux-In mode and go to the next mode.

### Display Selector (DISP)

This unit can display either the clock time or radio frequency/CD player functions. Ordinarily, the radio frequency or CD player track indication is displayed, but the unit will display the time when the DISP button is pressed. The time will display for approximately 5 seconds then return to the radio or CD player function display.

## SOUND SETTING

1. Press the [ EQ ] button to enter sound effect setting mode. First press shows current EQ. Rotate the knob to select the sound effect in this order:

OFF -> POP -> CLASS -> ROCK -> JAZZ -> USER

2. Press the [ EQ ] button, then press [  $\leftarrow$  ] or [  $\rightarrow$  ] button to select USER preset including: BALANCE -> FADER, rotate the knob to select a value.

BALANCE: LEFT 1-7->CENTER->RIGHT 1-7  
FADER: FRONT 1-7->CENTER->REAR 1-7

3. Press the [ EQ ] button and rotate the knob to the USER, on the USER mode press the knob to enter the setting. Press [  $\leftarrow$  ] or [  $\rightarrow$  ] button to select: BASS-G -> MIDDLE-G -> TREBLE-G, rotate the knob to select a value.

BASS-G: (-7) - (+7)  
MIDDLE-G: (-7) - (+7)  
TREBLE-G: (-7) - (+7)

**This unit can play back MP3/WMA files****Notes:**

If you play a WMA file with active DRM (Digital Rights Management), no audio is output.

**To disable DRM****(Digital Rights Management)**

When using Windows Media Player 9/10/11, click on Tool -> Options -> Copy music tab, then under Copy settings, unclick the Check box for Copy protect music. Then, reconstruct files.

Personally constructed WMA files are used at your own responsibility.

**Precautions when creating MP3/****WMA file****Usable sampling rates and bit rates**

1. MP3: Sampling rate 8 KHz-48 KHz, Bit rate 32-196kbps
2. WMA: Bit rate 8 kbps-320 kbps

**File extensions**

1. Always add a file extension ".MP3", ".WMA" to MP3, WMA file by using single byte letters. If you add a file extension other than specified or forget to add the file extension, the file cannot be played.
2. Files without MP3/WMA data will not play. The files will be played soundlessly if you attempt to play files without MP3/WMA data.

- \* When VBR files are played, the play time display may differ the play location.
- \* When MP3/WMA files are played, a little no sound part is caused between tunes.

**Logical format (File system)**

1. When writing MP3/WMA file on a CD-R disc or CD-RW disc, please select "ISO9660 level 1, 2 or Joliet or Romeo" or Apple ISO as the writing software format. Normal play may not be possible if the disc is recorded on another format.
2. The folder name and file name can be displayed as the title during MP3/WMA play but the title must be within 32 single byte alphabetical letters and numerals (including an extension).
3. Do not affix a name to a file inside a folder having the same name.

**Folder structure**

A disc with a folder having more than 8 hierarchical levels will be impossible.

**Number of files or folders**

1. Up to 999 files can be recognized per folder.
- Up to 3000 files can be played.
2. Tracks are played in the order that they were recorded onto a disc. (Tracks may not always be played in the order displayed on the PC.)
3. Some noise may occur depending on

the type of encoder software used while recording.

**Eject function**

Just pressing the [  ] button, ejects the disc even if the power to the unit was not turned on.

**Notes:**

- If you force a CD into before auto reloading, this can damage the CD.
- If a CD (12 cm) is left ejected for 15 seconds, the CD is automatically reloaded (Auto reload).

**Listening to a disc already loaded in the unit**



Press the [SRC] button to select the CD/MP3/WMA mode.

When the unit enters the CD/MP3/WMA mode, play starts automatically.

**Loading a CD**

Insert a CD into the center of the CD SLOT with label facing up. The CD plays automatically after loading.

**Notes:**

- Never insert foreign objects into the CD SLOT.
- If the CD is not inserted easily, there may be another CD in the mechanism or the unit may require service.
- Discs without the  or  mark and

- CD-ROMs cannot be played by this unit.
- Some CD-R/CD-RW discs may not be usable.

## Pausing play

1. Press the [1] button on the front panel or the [P/II] button on the remote control to pause play.
  2. "PAUSE" appears in the display.
- Press the above button again to resume CD play.

## Displaying CD titles

This unit can display title data for MP3/WMA disc.

When SCROLL is OFF, each time you press the [DISP] button to change the title display.

### MP3/WMA disc

FILE --> FOLDER --> TITLE --> ARTIST --> ALBUM

### Notes:

- If MP3/WMA disc is not input TAG, "NO TITLE" appears in the display.
- Only ASCII characters can be displayed in Tags.

## Selecting a track

### Track-up

1. Press the [▶▶] button to move to the beginning of the next track.
2. Each time you press the [▶▶] button, the

track advances to the beginning of the next track.

3. For MP3/WMA disc, press and hold the [6] button (1 sec.) to move ahead to +10 tracks.

### Track-down

1. Press the [◀◀] button to move back to the beginning of the current track.
2. Press the [◀◀] button twice to move back to the beginning of the previous track.
3. For MP3/WMA disc, press and hold the [3] button (1 sec.) to move back to -10 tracks.

## Fast-forward/Fast-reverse

### Fast-forward

Press and hold the [▶▶] button.

### Fast-reverse

Press and hold the [◀◀] button.

\* For MP3/WMA discs, it takes some time until the start of searching and between tracks. In addition, some error may occur in the play time.

## Folder select

This function allows you to select a folder containing MP3/WMA files and start playing from the first track in the folder.

1. Press the [3] or [6] button.  
Press the [3] button to move the previous folder. Press the [6] button to move the next folder.
2. To select a track, press the [◀◀] or [▶▶] button.

## Search Function

Press the [MENU], then rotate the knob to choose FOLD SCH or TRK SCH.

### Direct Song/File Access

1. Press the knob to enter the track list search mode.
2. Turn the knob to select a digit.
3. Press the knob to confirm entry and the tens digit will flash.
4. Turn the knob to select digit.
5. Repeat above steps to enter the hundreds and thousands digit, if necessary.

NOTE: The unit will only allow the selection of digits that correspond with the number of files on the media you are searching.

6. Once the track number appears on the screen, press the knob to play the selected song/file.

### Searching Folders/Files

1. Press the knob to enter the folder list search mode.
  2. Turn the knob to select a folder.
  3. Press the knob to enter the file list search mode. And then the track list appears in the display.
  4. Turn the knob to select a track.
  5. Press the knob to play.
- \* When play back MP3 / WMA file, this function is performed in the current folder.

## Top function

The top function resets the CD player to the

## CD/MP3/WMA OPERATIONS

first track of the disc. Press and hold the [ 1 ] button (1 sec.) to play the first track (track No. 1) on the disc.

### Other various play functions

#### Scan play

This function allows you to locate and play the first 10 seconds of all the tracks recorded on a disc.  
Press the [ 2 ] button to perform scan play.

#### Repeat play

This function allows you to play the current track repeatedly or play a track currently being played in the MP3/WMA folder repeatedly.

#### CD:

1. Press the [ 4 ] button once or more until "RPT ON" appears on the LCD to perform repeat play.
2. Press [ 4 ] button repeatedly until "RPT OFF" appears on the LCD to cancel repeat playback.

#### Random play

This function allows you to play the current track random play being played in the MP3/WMA folder.

#### CD:

1. Press the [ 5 ] button "RDM ON" appears on the LCD to perform random play.
2. Press the [ 5 ] button repeatedly until "RDM OFF" appears on the LCD to cancel random playback.

## USB PLAYBACK

1. Loading USB equipment  
Open the rubber cap, insert the USB into the connector and the unit play the music in the USB storer automatically, and the LCD will show USB.
2. Take out USB equipment  
Push the SFC button and switch to non USB mode, then take off the USB storer, close the rubber cap.

### USB Notes

USB functions (flash memory/ type) MP3 music play

1. USB flash memory 2 in 1 support.
2. Fat 16/fat 32 is possible.
3. File name : 32 byte/dir name : 32 byte/tag name : 32 byte
4. Tag (ID3 tag ver 2.0)  
- title/artist/album : 32 byte support.
5. USB 1.1 support, USB 2.0 support (It can not support USB 2.0 speed. Just, get the same speed with USB 1.1).  
Not all kinds of USB devices are compatible with the unit.



## TUNER OPERATION

### Band

During radio play, press the [BAND] button to choose between three FM, two MW bands.

### Up Tuning

Press the seek up [▶▶1] button to tune stations upward step-by-step. The current frequency will be shown in digital format on the display panel.

Press and hold the seek [▶▶1] button to the next available station.

### Down Tuning

Press the seek down [1◀◀] button to tune stations downward step-by-step.

Press and hold the seek down [1◀◀] button to the previous available station.

### Auto Store

Press the [PS/AS] button to scan preset stations 1-6. Hold it to automatically select six stations and store them in the current band. The new stations replace stations already stored in that band.

## MENU FUNCTION

At all mode, press and hold [DISP] button to enter system setup. Press [1◀◀] or [▶▶1] button to select options, rotate the knob to adjust.

### CLOCK

Press the knob to enter clock setting mode, rotate the knob to set hour, press the knob to confirm, then rotate the knob to set minute, press the knob again to save and exit setting.

### DXLO (RADIO mode)

Rotate the knob to choose radio local or distant at RADIO mode.

- LO: Only stations with strong signal can be received.
- DX: Stations with strong and weak signals can be received.

### VOL LAST: ON/OFF

Rotate the knob to choose the turn-on volume level is the volume level of latest power off ON or OFF.

### SCROLL: ON/OFF

For track information that is longer than the display panel:

When SCROLL is ON, the LCD will display ID3 TAG information cyclicly, e.g: TRACK->FILE->FOLDER->TITLE->ARTIST->ALBUM->TRACK->...

When SCROLL is OFF, the LCD will display one of the ID3 TAG information, the default is TRACK, but user can adjust it to other ID3 TAG information by press [DISP] button.

### BEEP: ON/OFF

Rotate the knob to choose button beep sound ON or OFF.

### 12/24H

Rotate the knob to choose time format 12 or 24 hour.

# ELECTRICAL CONNECTIONS

## Wiring Diagram

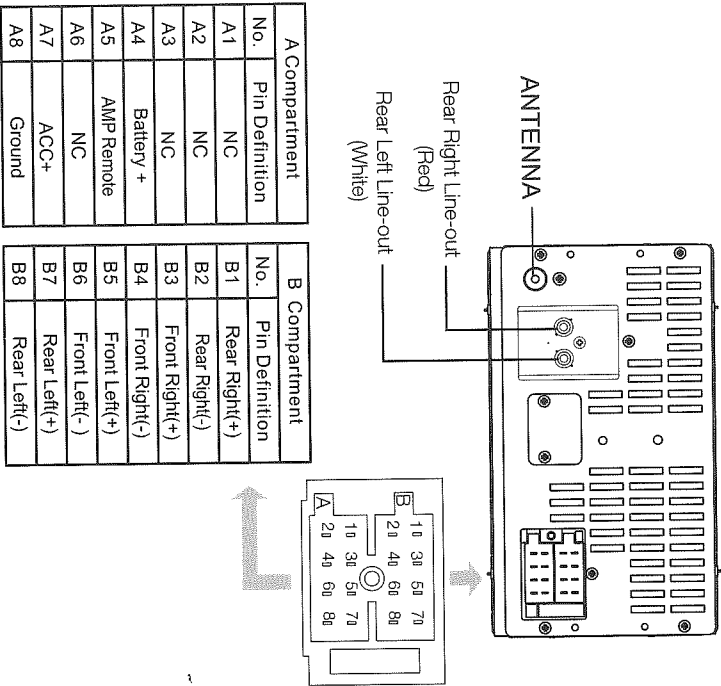

## Reset

Press the RESET button with a pointed object to reset the unit to the original status.

Note: Press the RESET button will erase the clock setting and stored stations.

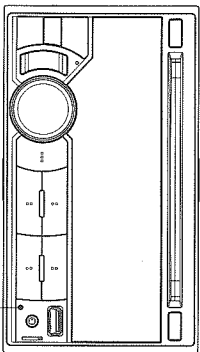

## Installation Procedures

1. If relevant, remove any other audio system from the car.
2. Insert the mounting sleeve into the dashboard. Fix it firmly in place by folding down the metal tabs.
3. Perform the required electrical connections.
4. Then check that everything works before installing the main unit.
5. Remove the two screws on the top of the unit, otherwise, the unit will not work.
6. Install the car radio in the dashboard using the supplied screws (M5x6mm).
7. Attach the outer trim frame.  
If you are not sure how to install this unit correctly, contact a qualified technician.

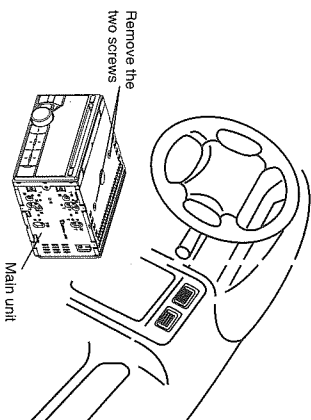

## TROUBLESHOOTING

The following checklist can help you solve some problems which you may encounter when using the unit. Before consulting it, check the connections and follow the instructions in the user manual. Do not use the unit in abnormal condition, for example without sound, or with smoke or foul smell can cause fire or electric shock, immediately stop using it and call the store where you purchased it.

Problem	Possible cause	Solution
<b>General</b>		
The unit will not switch on.	Car ignition is not on. Cable is not properly connected. Fuse is burnt.	Turn your car key in the ignition. Check cable connection. Replace fuse with a new fuse of the same capacity.
No sound	Volume is set at minimum or the mute function is on.	Check the volume or switch the mute function off.
The unit or screen does not work normally.	The unit system is unstable.	Press the RESET button.
<b>DISC mode</b>		
The appliance will not play discs.	The disc is inserted incorrectly. The disc is dirty or damaged.	Disc must be inserted with the label side facing up. Clean the disc and check for damage. Try another disc.
Sound skips due to vibration.	Mounting angle is over 30°. Mounting is unstable.	Adjust mounting angle to less than 30°. Mount the unit securely with the supplied parts.
<b>TUNER mode</b>		
Unable to receive stations.	The antenna is not connected properly.	Connect the antenna properly.
Poor quality reception of radio station.	The antenna is not fully extended or it is broken.	Fully extend the antenna and if broken, replace it with a new one.
Preset stations are lost.	The battery cable is not properly connected.	Connect the permanent live on the unit to the permanent live on the vehicle.
<b>USB mode</b>		
Unable to insert USB device.	The USB device has been inserted the wrong way round.	Insert it the other way around.
The USB device cannot be read.	NTFS format is not supported.	Check that the file system is in FAT or FAT32 format. Due to different formats, some models of storage devices or MP3 players may not be read.

# SPECIFICATION

## General

Power supply:	12V DC (11V-16V) Test voltage 14.4V, negative ground
Maximum power output:	45Wx4 channels
Continuous power output:	20Wx4 channels (4 $\Omega$ , 10% T.H.D.)
Speaker impedance:	2 $\Omega$ (4 to 8 $\Omega$ allowable)
Pre-Amp output voltage:	2.0V (CD play mode: 1KHz, 0 dB, 10 K $\Omega$ load)
Fuse:	15A
Dimensions(WxHxD):	178*100*167mm
Weight:	1.7kg
Aux-in:	$\geq$ 300mV

## FM Stereo Radio

Frequency range:	87.5-108.0MHz
Usable sensitivity:	8 dB $\mu$
Quieting sensitivity(S/N=50dB):	12 dB $\mu$
Frequency response:	30Hz-15KHz
Stereo separation:	30dB (1KHz)
Image response ratio:	50dB
IF response ratio:	70dB
Signal/noise ratio:	55dB

## AM(MW) Radio

Frequency range:	522-1620KHz
Usable sensitivity(S/N=20dB):	30 dB $\mu$

## Disc Player

System:	Disc digital audio system
Frequency response:	20Hz-20KHz
Signal/noise ratio:	>80 dB
Total harmonic distortion:	Less than 0.20% (1KHz)
Wow and flutter:	Below measurable limits
Channel separation:	>55 dB

## Components

Operating instructions	1
Screw	4
Rim	1
Remote control	1
Mounting bolt	1
Rubber cushion	1

Note: Specifications and the design are subject to change without notice due to improvements in technology.

PN:127075006529